

Sorrento 2™

Chairs,
engineered
for care.





Born out of human understanding and clinical know-how, our therapeutic chairs are engineered and built to support the body where it most needs support. Adapting to the individuals' needs and allowing weight distribution on pressure points to be spread; our chairs alleviate the stress on the user and the strain on the carer.



Contents

- 3 Introduction
- 4 Overview
- 6 Features
- 8 Additional Features
- 10 4 Principles of Effective Clinical Seating
- 13 Testimonials
- 14 Parts & Accessories
- 15 Technical Specifications
- 16 Infection Control



Sorrento 2™

Incorporating caregiver, clinical and patient feedback, Sorrento 2™ has been engineered to offer the highest levels of clinical support for patients while offering caregivers an enhanced user experience when caring for their patients.

The features of the Sorrento 2™ combine global clinical seating guidelines with the Seating Matters™ '4 Principles of Effective Clinical Seating.' The chair is designed to help in the prevention of pressure injuries, sliding and falls from the chair, and to encourage early mobilisation for patients who spend the majority of their time in bed.

Improved adjustability and configuration features ensure that caregivers can easily configure the chair to maximise patient clinical wellbeing and comfort.

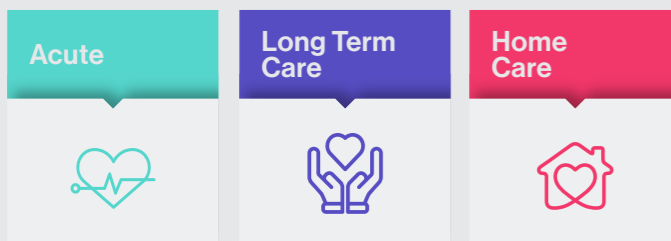

Sorrento 2™ Features

1 Higher elevating and extending leg rest with wider calfpad and footplate

Improves pressure loading.¹ Reduces chance of legs falling between gaps at front of chair.

2 Adjustable seat width

More accurate patient positioning and accommodates body shape changes.

3 Incorporates both 30° and 45° tilt in space

Enhanced options in repositioning and pressure loading in line with clinical guidelines.²

4 Configurable back

Switches easily between waterfall and lateral backs for most appropriate postural support.

5 Adjustable back height

For a wider range of patients without requirement for bespoke adaptations.



Watch our full-feature video

Scan the QR code with your phone camera or visit YouTube to watch.



Sorrento 2™

Additional Features

① **Higher elevating and extending leg rest**
Improves comfort and loading for pressure management.



⑦ **Stand aid compatibility**
Simple, safe and effective stand transfers promoting mobilisation.⁴

② **Improved cushion performance**
Offers greater envelopment for pressure management and comfort.³

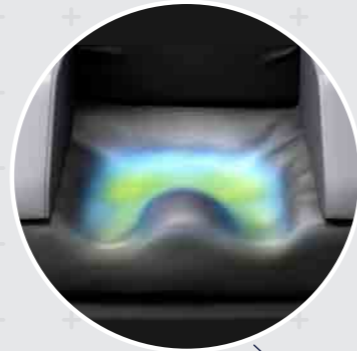

③ **Arm height adjustability**
Helps achieve correct postural position and loading of the arms.

④ **Integrated charger and handset with holder***
Means no more lost charging plugs.

⑤ **Washable actuators and control box with lithium battery***
Improves infection control, reliability and battery life.

⑥ **Tool-free seat depth adjustability**
Enables correct patient positioning in chair.

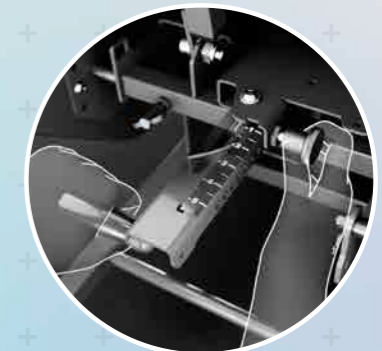

4 Principles of Effective Clinical Seating



Load the Body

Ensure full body is in contact with the chair to redistribute pressure from bony prominences. Don't forget to load the feet! 19% of body weight goes through our feet.¹

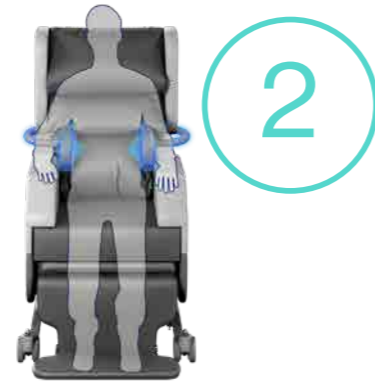

Provide Postural Support

Accommodate fixed deviations and correct flexible deviations to prevent further progression of deformities and avoid uneven pressure redistribution.



Effective Repositioning

Guidelines recommend that seated individuals are repositioned frequently to increase blood flow to skin. Functions such as tilt in space and back angle recline make this easier.



Appropriate Surface

All weight-bearing parts of the chair should facilitate immersion, envelopment and support of the patient's body. The surfaces of Seating Matters chairs are made of high performance pressure distributing materials with a multi-stretch Dartex covering.





Testimonials

“The chairs are very supportive and highly adaptable, meaning one chair can help us meet the needs of various patients with differing conditions coming through the ward”

**Jody Jones, OT Specialist in Palliative Care
St Ann’s Hospice, England**

“We use the Sorrento and Milano chairs at our hospice as we often require seating to support people who have Motor neurone disease (MND), Multiple sclerosis (MS) and others with changing needs owing to progressive disease.

I recently supported a lady who had suffered an ‘event’ which resulted in right sided weakness. We used the Sorrento with right lateral support to enable her to sit out safely and comfortably.

I feel that Seating Matters chairs are invaluable in meeting the dying wishes and goals for patients, their families and their care team.”

**Lucy Smith, Occupational Therapist
Coalville Community Hospital**

“We have hired a number of Sorrento and Phoenix chairs for our wards. We find them excellent chairs for our patients, with very good functionality to help the nursing team and caregivers.

The chairs are very supportive and highly adaptable, meaning one chair can help us meet the needs of various different patients. When someone has been discharged, the chair can easily be reconfigured to accommodate the next patient who may be a different size. The Seating Specialist reps we work with are very knowledgeable on which chair to choose. They are very easy to deal with and have been helpful in getting chairs delivered when we need them.”

Parts & Accessories



1 Horseshoe Head Pillow



2 Concave Head Pillow



3 Ramped Cushion



4 Dual Castors



5 Lateral Supports



6 Padded Footplate



7 Seat Belt



8 Leg Laterals



Technical Specifications

Basic Dimensions

A Overall Height*	Standard: 50" / 1270mm Range: 48"-54" / 1220mm-1370mm
B Back Height	Standard: 28" / 710mm Range: 26"-32" / 660mm-810mm
C Seat Height*	24" / 600mm 49" / 1250mm
D Overall Length	

*Height measurements are based on 100mm castors.

Footplate Height Adjustments (from seat)

E High	15" / 380mm
F Low	20" / 510mm

Available Seat and Overall Widths

G (Seat Width)	H (Overall Width)
14" / 350mm*	25" / 660mm
16" / 400mm	25" / 660mm
18" / 450mm	26" / 670mm
20" / 500mm	28" / 720mm
22" / 550mm	30" / 770mm
24" / 600mm	32" / 820mm

* This seat width is achieved using a 400mm/16" seat width and a set of 25mm/1" padded arm covers.

Arm Height Options (from seat cushion)

I Low	6" / 160mm
J Medium	7" / 185mm
K High	8" / 210mm

Seat Depth

L	17 - 22" / 430mm - 550mm
---	--------------------------

Clearance Height

M	5" / 130mm*
---	-------------

*Height measurements are based on 100mm castors.

Full Recline Length

N	69" / 1750mm
---	--------------

Recline and Tilt Angles

ii Back Angle Recline
90° - 130°
40° range

iii Leg Rest Angle
80° - 150°
70° range

iv Tilt in Space

From 5° forward, or anterior, tilt to 30° or 45° backward tilt (dependent on chair model)

Chair Weight Unloaded

Motorised: 10 Stone / 64 Kg / 141 lb

Manual: 8 Stone / 51 Kg / 111 lb

Patient Weight Limit

31.5 Stone / 200 Kg / 440 lb

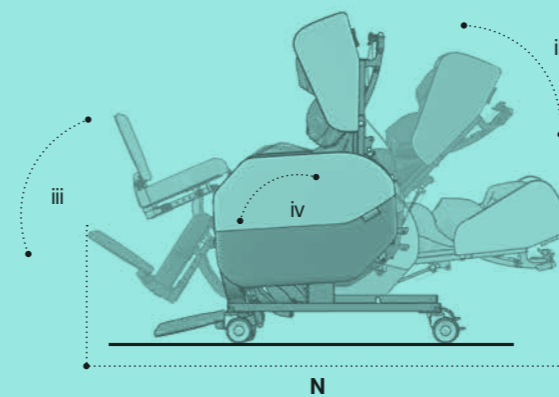
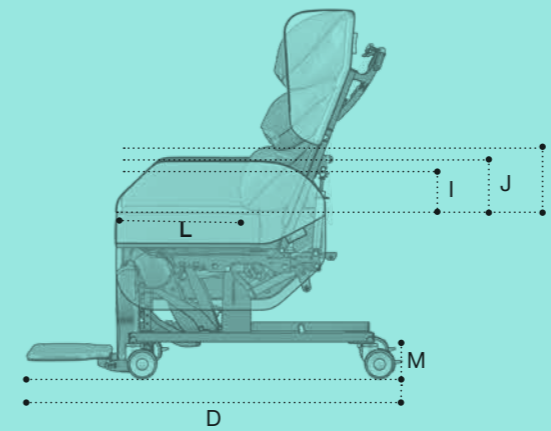
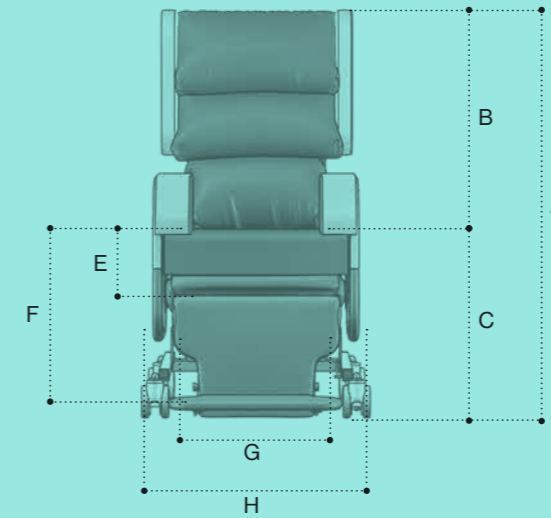



Infection Control

Infection prevention is vitally important in the home, hospital and healthcare environments. Bacteria and germs often contribute to the development and spread of infections. They can potentially be very harmful so this is important to control and prevent, especially in areas such as hospitals, where patients may be vulnerable and susceptible to infection.

At Seating Matters we take infection control very seriously. Our chairs have been specifically designed to decrease entrapment areas where bacteria can survive. The chairs can generally be cleaned using the same process and materials as hospital grade beds and mattresses.

Dartex is a proven multi-stretch patient contact surface with bio-static (anti-mycotic) coatings. It is waterproof, stain resistant, flame retardant and has multi-directional stretch for pressure redistribution. It is used on the seat cushion, calf panels, lateral supports and seat back.

- 1 All chairs are upholstered in a hard-wearing, enduring vinyl material proven to counteract C.difficile, E.coli as well as MRSA and the vast majority of bacteria.
- 2 The materials can all be cleaned with hospital-grade cleaning agents, without causing damage to the fabrics. Please refer to the instructions on the specific cleaning solution you intend to use for best results.
- 3 The seat cushion is removable for ease of cleaning.
- 4 The seat cushion is attached to the base of the chair with a non-slip, wipeable surface therefore having no materials such as Velcro which can hold dirt and bacteria.
- 5 All electric components are part of a sealed unit which can be wiped clean.

- 6 The metal frames of the chairs have a powder coated finish which is electro-statically applied then cured under heat to allow it to form a "skin". The powder is a thermoset polymer and is used to create a hard finish that is tougher than conventional paint, therefore protecting the frame from being exposed to outside conditions and thus preventing rusting.
- 7 All chairs have modular parts which means the chair can be completely dismantled leaving no areas unexposed for cleaning.
- 8 The complete chair frame is designed with flat panels throughout which can be easily wiped clean.
- 9 Patient contact surfaces are Dartex. This fabric is waterproof, has the ability to be wiped clean and has bio-static (anti-mycotic) coatings to provide an impenetrable barrier to virus and bacteria.

Our chairs are used by:



Seating Matters are an ISO 9001 Quality Management System approved company.
© Seating Matters. Published May 2023

Build quality

It takes continuous, careful planning to ensure our chairs are functional as well as being aesthetically pleasing. Our design team are adamant that the chairs need to be designed in such a way that they fit into a home environment. Each and every part of a Seating Matters chair has been engineered and devised to offer optimum quality and support for the user.

Ease of use

All Seating Matters chairs can be adjusted without tools in less than one minute. Useful to easily and efficiently adjust the chair to suit the user or to readjust for use within a multi-user environment.

References

1. Staas, W.E., Cioschi, H.M. (1991). Pressure sores: a multifaceted approach to prevention and treatment. Western Journal of Medicine, 154, 539-544.
2. Tierney, M. (2022). The Clinician's Seating Handbook, A Reference Guide for Clinical Seating Provision, 6, 62-63
3. Trelleborg (2019). Retrieved May 7, 2022. Are You Sitting Comfortably? <https://www.trelleborg.com/engineered-coated-fabrics/-/media/engineered-fabrics/dartex/dartex-pdfs/2019-are-you-sitting-comfortably-ecf-dartex.pdf>
4. National Institute for Health and Care Excellence (NICE) (2009). Retrieved May 10, 2023. Rehabilitation after critical illness in adults [CG83]. <https://www.nice.org.uk/guidance/cg83>.

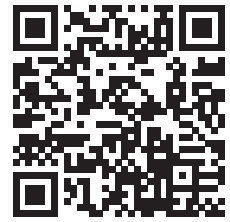

N. Ireland & ROI

131 Carnamuff Road

Limavady

Northern Ireland

BT49 9JG

T +44 (0) 28 777 666 24

contact@seatingmatters.com

USA

300 International Dr

Suite 100, Buffalo

New York, USA

NY 14221

T +1 (905) 507 9007

usa@seatingmatters.com

Australia

9/256 New Line Road

Dural

NSW 2158

Australia

T +61 1300 001 050

info@seatingmatters.com.au